

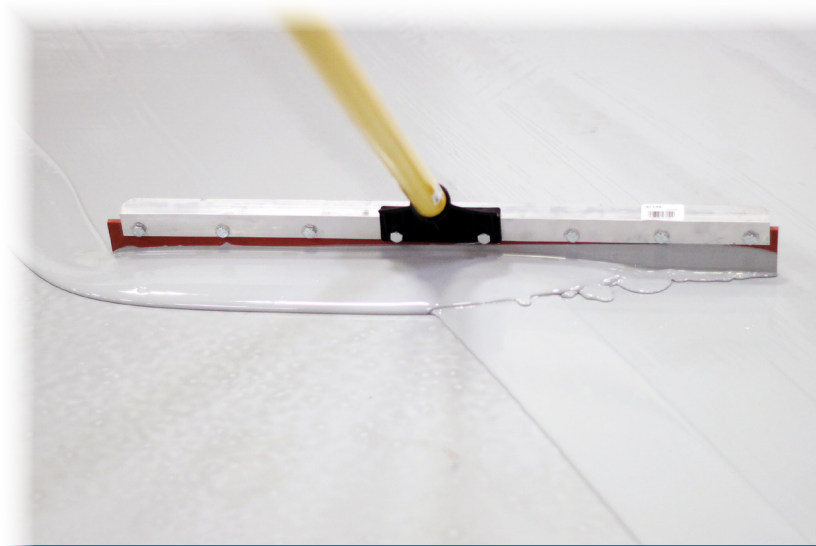

MIDWEST RAKE®

COATINGS APPLICATION TOOLS & SUPPLIES



SEYMOUR
MIDWEST

WWW.SEYMOURMIDWEST.COM



Seymour Midwest is a family-owned, global supplier to the hand-tools market, providing both innovative solutions and time-tested products from our manufacturing facilities in Indiana and Tennessee.

The quality, dependability, and performance of our products meet the high standards of those who use tools everyday: contractors, handymen, farmers, ranchers, landscapers and others. Our diverse selection of products and brands allows our customers to order all of their tool needs from a single source.

Beyond best-in-class products, Seymour Midwest is also known as a leader in outstanding customer service, product training, and technical support in all of our business segments.

As a family-owned company, we believe in the values of integrity, quality, commitment, and innovation. We work hard to achieve performance that sets a standard of excellence and to build relationships with our customers that endure, not just because it is good business, but because it is the right thing to do. Today the family-owned company sells over 3,500 tools and 8,000 different repair handles to customers worldwide.

The Midwest Rake® brand is proud to be one of the “founding fathers” in manufacturing quality tools for those contractors who apply and finish protective industrial and marine floor and surface coatings and those concrete “artisans” who have changed the world of concrete forever with their decorative concrete talents.



- **Innovative high quality tools for the coatings industry.**
- **Widest selection of pro-grade tools and supplies for applying coatings and decorative concrete.**
- **Smart new merchandising solutions and displays.**
- **Dedicated and knowledgeable local sales support to help you grow your business.**

TABLE OF CONTENTS

Brooms / Brushes / Scrapers	22
CAM® / Gauge Rakes	10-12
Footwear	4-5
Merchandising Solutions	26-27
Miscellaneous Tools	24
Mixers & Measuring Wheels	25
Poles & Extension Handles	23
Roller Covers & Frames / Chip Brushes	
<i>Specialty Roller Covers</i>	15-16
<i>Roller Covers</i>	16-17
<i>Chip Brushes</i>	17
<i>Mini Rollers and Frames</i>	17
<i>Roller Gauges & End Caps</i>	18
<i>Frames</i>	18
Spiked / Stub & Ribbed Rollers	19-21
Squeegees	
<i>Application Squeegees</i>	6-7
<i>Replacement Blades</i>	6-7
<i>Speed Squeegees</i>	8
<i>Do-It-Yourself / Miscellaneous Squeegees</i>	9
Trowels / Smoothers & Spreaders	13-14

Concrete Finishing & Resinous Floor Coating Shoes

It's never been easier to install epoxy coatings or self-leveling and decorative overlays. With a patented design, Shoe-In® Pro shoes are a fantastically simple and affordable solution with multiple applications.

APPLICATIONS INCLUDE:

Installing Epoxy Coatings | Installing Concrete & Screed Floors Including Decorative Overlays
Industrial Environments | Renovations or Removals | Any Area Where Flooring Needs Protecting



SLIPS ON IN SECONDS

HANDS FREE! PUT AN END TO FRUSTRATIONS WITH STRAPS, BUCKLES AND ADJUSTMENTS ON TRADITIONAL FLOOR FINISHING SHOES.

COMFORTABLE

GOES OVER YOUR EXISTING SHOES OR BOOTS. STAYS SNUG WHETHER YOU'RE STANDING OR KNEELING. WIDE BASE FOR STABILITY.

TIME SAVING

ALLOWS YOU TO TAKE PROTECTIVE SHOES ON AND OFF AS NEEDED TO GET THE JOB DONE.



FLAT STYLE

FOR CONCRETE INSTALLATION. NO TREAD MARKS OR HEEL MARKS. IDEAL FOR DECORATIVE CONCRETE STAMPING AND GENERAL SURFACE TROWELING.



SHARP SPIKED STYLE

FOR RESINOUS / EPOXY FLOOR COATING INSTALLATION. MARK-FREE INSTALLATIONS. SHARP OR ROUNDED REPLACEMENT SPIKES ARE AVAILABLE.

Item No.	Description	Pack Qty
46161	Concrete Finishing Shoe - Medium	12
46162	Concrete Finishing Shoe - Large	12
46163	Concrete Finishing Shoe - Extra- Large	12

Item No.	Description	Pack Qty
46171	Spiked Shoes - Sharp - for Resinous Coatings - Medium	6
46172	Spiked Shoes - Sharp - for Resinous Coatings - Large	6
46173	Spiked Shoes - Sharp - for Resinous Coatings - Extra-Large	6
46131	Replacement Spikes - Sharp (Set of 32 - 16 Per Shoe)	1
46132	Replacement Spikes - Rounded (Set of 32 - 16 Per Shoe)	1

SIZING - SELECT YOUR SIZE TO FIT OVER EITHER BOOTS OR SNEAKERS

MEDIUM

FITS BOOT SIZE 9 AND UNDER
FITS SNEAKER SIZE 9 AND UNDER

LARGE

FITS BOOT SIZES 10 TO 11
FITS SNEAKER SIZE 10 TO 12

EXTRA-LARGE

FITS BOOT SIZES 12 TO 16
FITS SNEAKER SIZE 13 TO 16



Made for Midwest Rake® by

“Flexible Bed” Spiked Shoes

- Revolutionary - perfect fit, balance and flexibility
- For use with high performance floor coatings
- The safest spiked shoes available
- Snap-lock buckle system

- 20 replaceable spikes per shoe
- Toe and heel guards
- Fits like a shoe



Sharp Tip Flexible Bed Spiked Shoes

Item No. Description

46141	Size Medium (Shoe size 8 to 9-1/2)
46142	Size Large (Shoe size 10 to 11-1/2)
46143	Size Extra-Large (Shoe size 12 to 13-1/2)
46129	Replacement Spikes (set of 40)

1/2" spike length on sharp tip

Rounded Tip Flexible Bed Spiked Shoes

Item No. Description

46151	Size Medium (Shoe size 8 to 9-1/2)
46152	Size Large (Shoe size 10 to 11-1/2)
46153	Size Extra-Large (Shoe size 12 to 13-1/2)
46130	Replacement Spikes (set of 40)

7/8" spike length for use with high-build, cementitious and decorative concrete toppings. No more punctured primer coats!



Black Spiked Shoes

- Durable solvent-resistant polypropylene
- Snap-lock buckle system
- Sharp or rounded tip spikes
- 3/4", 1" and 1-1/2" spike lengths
- 13 specially placed spikes per shoe
- Replacement spikes (see below)

Steel Spiked Shoes

- More flexible and durable
- Snap-lock buckle system
- 3/4" or 1" spike lengths
- Replacement spikes (see below)

Red “Acid-Resistant” Spiked Shoes

- 3/4" acid-resistant stainless steel spikes
- Acid-resistant footbeds
- Snap-lock buckle system
- Replacement sharp spikes (see below)

Asphalt Shoes

- Heavy, riveted felt-soled shoes (pair)
- Contractor's choice for comfort and protection

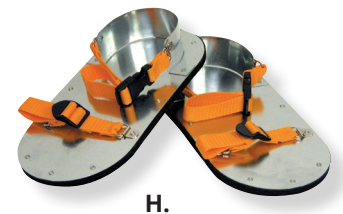
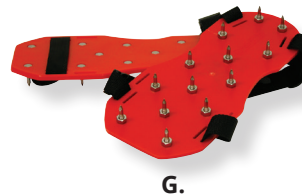

Item No. Description

A. 46106	Black Spiked Shoes 3/4" Sharp Spikes (Pair)
B. 46107	Black Spiked Shoes 1" Sharp Spikes (Pair)
C. 46110	Black Spiked Shoes 1-1/2" Sharp Spikes (Pair)
D. 46112	Black Spiked Shoes 3/4" Rounded Spikes (Pair)
E. 46103	Steel Spiked Shoes with 3/4" Sharp Spikes (Pair)
F. 46104	Steel Spiked Shoes with 1" Sharp Spikes (Pair)
G. 46108	Red “Acid-Resistant” Sharp Spiked Shoes (Pair)
H. 46102	Riveted Asphalt Shoes (Pair)

Item No. Description

46120	Replacement Straps for A, B, C, D and G (Set of 4 - 2 Each Shoe)
46121	Replacement Straps for E and F (Set of 6 - 3 Each Shoe)
46122	3/4" Rounded Tip Replacement Spikes for D (Set of 26 - 13 / Shoe)
46125	3/4" Sharp Tip Replacement Spikes for A & E (Set of 26 - 13 / Shoe)
46126	1" Sharp Tip Replacement Spikes for B & F (Set of 26 - 13 / Shoe)
46127	1-1/2" Sharp Tip Replacement Spikes for C (Set of 26 - 13 / Shoe)
46128	3/4" Acid Resistant Replacement Sharp Spikes for G (Set of 26 - 13 / Shoe)

Application Squeegees

Step 1 - Choose the frame

Midwest Rake® branded application squeegee frames are the standard in the Protective Coating industry. These “clamp-style” frames make it easy to change blades.



Frame Width

Description	Item No. 16"	Item No. 24"	Item No. 30"	Item No. 36"	Item No. 48"
Application Squeegee Frame with THA*	78000	78010	78015	78020	78040
Application Squeegee Frame with 66" PCAH**	78100	78110	78115	78120	78140
Application Squeegee Frame with 82" PCAH**	78200	78210	78215	78220	78240

*Threaded Handle Adapter **Powder-Coated Aluminum Handle

What squeegee notch width / notch depth should I use to apply 10 mils of epoxy? At Midwest Rake®, the answer is **always** refer to our “Nominal Wet Film Thickness Chart” to determine the appropriate notch width / notch depth required for your job. Our squeegee blades have a unique design - shallower depth notches enable Midwest Rake® squeegees to stand out from the competition ensuring a consistent and tight range of wet film thickness delivery.

NOMINAL WET FILM THICKNESS CHART

Description	Notch Width	Notch Depth	Nominal Wet Film (WFT) Delivered in Mils*
1/8" V-Notch	1/8"	1/16"	8 - 12
3/16" V-Notch	3/16"	3/32"	15 - 20
1/4" V-Notch	1/4"	1/8"	20 - 28
3/8" V-Notch	3/8"	1/4"	30 - 45
1/2" V-Notch	1/2"	3/8"	50+

*The chart conversions to the right are not absolutes and are provided to help guide blade selection. Many factors can contribute to the actual wet film thickness produced; including: pressure exerted on the blade, porosity of the substrate (concrete) being coated, material being used and if and how the back-roll is completed. If you have any questions or would like to discuss the particulars of your project - please contact us at 844-SEYMOUR and we would be more than happy to provide guidance in the application squeegee selection process.

Step 2 - Choose the blade

Our blades are available in Neoprene, EPDM and Red Rubber. All blades are “reversible” (notched on both sides). Each type is available in a variety of head widths and notch sizes. **SEE PAGE 8 FOR SELECTING THE APPROPRIATE STYLE OF RUBBER.**



Neoprene

EPDM

Red Rubber

EXCLUSIVE
Rubber is also available by the roll.



Our standard Neoprene, EPDM and Red Rubber are available in 25' rolls. Please see the chart below for product information.

Description	Standard Neoprene Notched on both sides	Standard EPDM Notched on both sides	2" Red Rubber Notched on both sides
25' Roll No-Notch (Flat) Rubber	79405	79505	79605
25' Roll 1/8" Notch Rubber	79410	79510	79610
25' Roll 3/16" Notch Rubber	79415	79515	79615
25' Roll 1/4" Notch Rubber	79420	79520	79620
25' Roll 3/8" Notch Rubber	79425	79525	79625
25' Roll 1/2" Notch Rubber	79430	79530	79630

Blade Width

Description	Item No. 16"	Item No. 24"	Item No. 30"	Item No. 36"	Item No. 48"
Neoprene No-Notch (Flat) Reversible Squeegee Blade	79005	79010	79013	79015	79020
Neoprene 1/8" Notch Reversible Squeegee Blade	79025	79030	79033	79035	79040
Neoprene 3/16" Notch Reversible Squeegee Blade	79045	79050	79053	79055	79060
Neoprene 1/4" Notch Reversible Squeegee Blade	79065	79070	79073	79075	79080
Neoprene 3/8" Notch Reversible Squeegee Blade	79085	79090	79093	79095	79100
Neoprene 1/2" Notch Reversible Squeegee Blade	79105	79110	79113	79115	79120
EPDM No-Notch (Flat) Reversible Squeegee Blade	79205	79210	79213	79215	79220
EPDM 1/8" Notch Reversible Squeegee Blade	79225	79230	79233	79235	79240
EPDM 3/16" Notch Reversible Squeegee Blade	79245	79250	79253	79255	79260
EPDM 1/4" Notch Reversible Squeegee Blade	79265	79270	79273	79275	79280
EPDM 3/8" Notch Reversible Squeegee Blade	79285	79290	79293	79295	79300
EPDM 1/2" Notch Reversible Squeegee Blade	79305	79310	79313	79315	79320
Red Rubber No-Notch (Flat) Reversible Squeegee Blade	79705	79710	79713	79715	79720
Red Rubber 1/8" Notch Reversible Squeegee Blade	79725	79730	79733	79735	79740
Red Rubber 3/16" Notch Reversible Squeegee Blade	79745	79750	79753	79755	79760
Red Rubber 1/4" Notch Reversible Squeegee Blade	79765	79770	79773	79775	79780
Red Rubber 3/8" Notch Reversible Squeegee Blade	79785	79790	79793	79795	79800
Red Rubber 1/2" Notch Reversible Squeegee Blade	79805	79810	79813	79815	79820

Application Squeegees

Frame & blade combo - you supply the handle



Description	For Handle Options See Page 23	Frame Width	
		Item No. 16"	Item No. 24"
Application Squeegee Frame with No-Notch (Flat) Reversible EPDM Blade with THA*		78546	78554
Application Squeegee Frame with No-Notch (Flat) Red Rubber Blade with THA*		78548	78556
Application Squeegee Frame with 1/8" Notched Reversible EPDM Blade with THA*		78118	78128
Application Squeegee Frame with 1/8" Notched Red Rubber Blade with THA*		-	78129
Application Squeegee Frame with 3/16" Notched Reversible EPDM Blade with THA*		78116	78126
Application Squeegee Frame with 3/16" Notched Red Rubber Blade with THA*		-	78323
Application Squeegee Frame with 1/4" Notched Reversible EPDM Blade with THA*		78114	78124
Application Squeegee Frame with 1/4" Notched Red Rubber Blade with THA*		-	78125
Application Squeegee Frame with 1/2" Notched EPDM Blade, THA*		-	78122

*THA=Threaded Handle Adapter

Hand-Held Squeegee

You can go back again and again to the hardware store or home center to buy window squeegees, or you can just change the 8" wide blade in this quality built, hand-held squeegee. It is used to fill depressions and cracks in a floor prior to the application of any protective coating product. You can also use it to spread any material, including slurries and highly viscous and cementitious mixes. The blade is clamped in a durable 8" wide aluminum frame, not bolted through, making it easy to replace. The handle is a 6" non-slip vinyl grip over an aluminum core.

EXCLUSIVE

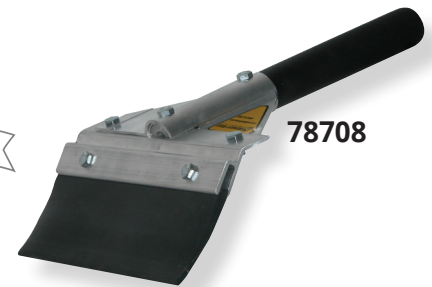

Item No.	Description
78708	Hand-Held Squeegee, 3" Flexible Rounded Edge Neoprene Blade
78709	Hand-Held Squeegee, 2" More Rigid Square Edge Neoprene Blade
78108	8" Hand-Held Squeegee Frame

Crack Filler Squeegees

Push/Pull V-Crack Filler Squeegee

This tool is designed to work as a push or pull squeegee by simply reversing the socket attachment. No tools required. The "V" is at a 70 degree angle, using a 1/4" x 2" neoprene rubber blade. The 2" height adds greater containment and control of material.

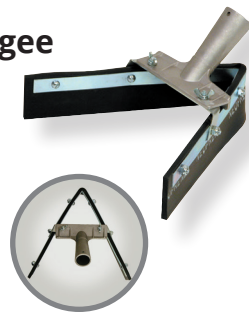

Heavy-Duty U-Crack Filler Squeegee

This squeegee is built for durability. It has a steel frame with a 5/16" x 2-1/4" neoprene rubber blade. The 9-1/2" deep by 3" U-shaped cavity holds plenty of material. Replacement blades are available.



Lightweight U-Crack Filler Squeegee

This squeegee is inexpensive, but effective. It is lightweight, easy to use and is great for filling cracks prior to applying floor coatings or seal coating material. The replaceable blade has an inside width of 2-1/2". The blade height is 1-1/4".



For Crack Filler Squeegee Handle Options See Page 23

Item No.	Description
46002	Lightweight U-Crack Filler Squeegee
SP50121	Replacement Blade (for 46002)
46001	Heavy-Duty U-Crack Filler Squeegee
SP50120	Replacement Blade (for 46001)
46005	Push / Pull V-Crack Filler Squeegee
SP50122	Replacement Blade (for 46005)

SQUEEGEES - SPEED

A complete line of non-replaceable blade squeegees for general purpose and coatings application needs. Improved notching design provides a more accurate material delivery with longer wear. Heavy-duty aluminum frame with heavy-duty polymer threaded handle adapter that's guaranteed not to break. 20% lighter design vs. competitive tools.

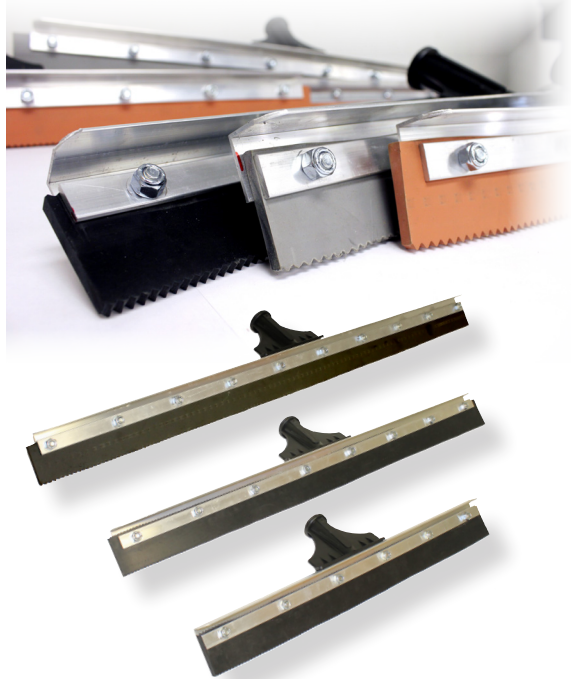

Heavy-Duty Polymer Threaded Handle Adapter

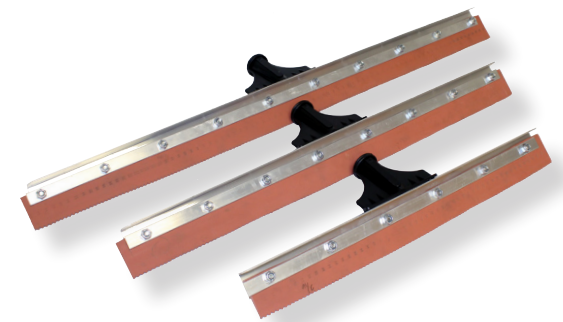

Primarily used as a general purpose tool and by seal coating, water proofing (deck coatings) to apply product. Provides good chemical resistance and is the stiffest blade available. (Can leave marks on coatings).

BLACK NEOPRENE

47136	Midwest Rake® Speed Squeegee, 18", Flat, Black Neoprene
47137	Midwest Rake® Speed Squeegee, 18", 1/8" Notch, Black Neoprene
47138	Midwest Rake® Speed Squeegee, 18", 3/16" Notch, Black Neoprene
47139	Midwest Rake® Speed Squeegee, 18", 1/4" Notch, Black Neoprene
47146	Midwest Rake® Speed Squeegee, 24", Flat, Black Neoprene
47147	Midwest Rake® Speed Squeegee, 24", 1/8" Notch, Black Neoprene
47148	Midwest Rake® Speed Squeegee, 24", 3/16" Notch, Black Neoprene
47149	Midwest Rake® Speed Squeegee, 24", 1/4" Notch, Black Neoprene
47156	Midwest Rake® Speed Squeegee, 30", Flat, Black Neoprene Rubber
47157	Midwest Rake® Speed Squeegee, 30", 1/8" Notch, Black Neoprene
47158	Midwest Rake® Speed Squeegee, 30", 3/16" Notch, Black Neoprene
47159	Midwest Rake® Speed Squeegee, 30", 1/4" Notch, Black Neoprene

A favorite among epoxy flooring, deck coating and decorative concrete contractors. Gray EPDM has excellent chemical resistance, is moderately stiff and is non-marking.

GRAY EPDM

47164	Midwest Rake® Speed Squeegee, 18", Flat, Gray EPDM
47165	Midwest Rake® Speed Squeegee, 18", 1/8" Notch, Gray EPDM
47166	Midwest Rake® Speed Squeegee, 18", 3/16" Notch, Gray EPDM
47167	Midwest Rake® Speed Squeegee, 18", 1/4" Notch, Gray EPDM
47174	Midwest Rake® Speed Squeegee, 24", Flat, Gray EPDM
47175	Midwest Rake® Speed Squeegee, 24", 1/8" Notch, Gray EPDM
47176	Midwest Rake® Speed Squeegee, 24", 3/16" Notch, Gray EPDM
47177	Midwest Rake® Speed Squeegee, 24", 1/4" Notch, Gray EPDM
47184	Midwest Rake® Speed Squeegee, 30", Flat, Gray EPDM
47185	Midwest Rake® Speed Squeegee, 30", 1/8" Notch, Gray EPDM
47186	Midwest Rake® Speed Squeegee, 30", 3/16" Notch, Gray EPDM
47187	Midwest Rake® Speed Squeegee, 30", 1/4" Notch, Gray EPDM
47120	Midwest Rake® Speed Squeegee, 36", Flat, Gray EPDM
47121	Midwest Rake® Speed Squeegee, 36", 1/8" Notch, Gray EPDM
47122	Midwest Rake® Speed Squeegee, 36", 3/16" Notch, Gray EPDM
47123	Midwest Rake® Speed Squeegee, 36", 1/4" Notch, Gray EPDM

The choice among epoxy flooring, deck coating, and decorative concrete contractors who prefer a softer blade. Red santoprene provides excellent chemical resistance and is non-marking.

RED RUBBER

47140	Midwest Rake® Speed Squeegee, 18", Flat, Red Rubber
47141	Midwest Rake® Speed Squeegee, 18", 1/8" Notched, Red Rubber
47142	Midwest Rake® Speed Squeegee, 18", 3/16" Notch, Red Rubber
47143	Midwest Rake® Speed Squeegee, 18", 1/4" Notch, Red Rubber
47150	Midwest Rake® Speed Squeegee, 24" Flat, Red Rubber
47151	Midwest Rake® Speed Squeegee, 24", 1/8" Notch, Red Rubber
47152	Midwest Rake® Speed Squeegee, 24", 3/16" Notch, Red Rubber
47153	Midwest Rake® Speed Squeegee, 24", 1/4" Notch, Red Rubber
47160	Midwest Rake® Speed Squeegee, 30" Flat, Red Rubber
47161	Midwest Rake® Speed Squeegee, 30", 1/8" Notch, Red Rubber
47162	Midwest Rake® Speed Squeegee, 30", 3/16" Notch, Red Rubber
47163	Midwest Rake® Speed Squeegee, 30", 1/4" Notch, Red Rubber

Do-It-Yourself Squeegees

Co-extruded blade and frame construction; very lightweight and easy to control. *Blade is not replaceable.*

Item No.	Description
78731	12" Squeegee with 1/16" Notches
78750	18" Squeegee, No-Notch
78751	18" Squeegee with 1/16" Notches
78752	18" Squeegee with 1/8" Notches
78753	18" Squeegee with 3/16" Notches
78760	22" Squeegee, No-Notch
78761	22" Squeegee with 1/16" Notches
78762	22" Squeegee with 1/8" Notches
78763	22" Squeegee with 3/16" Notches

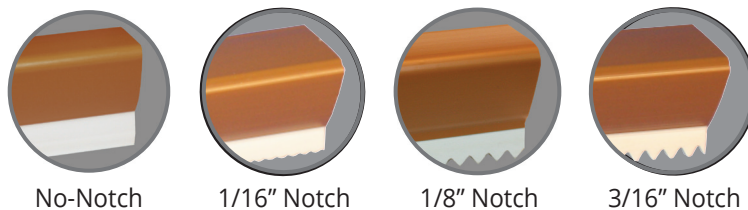
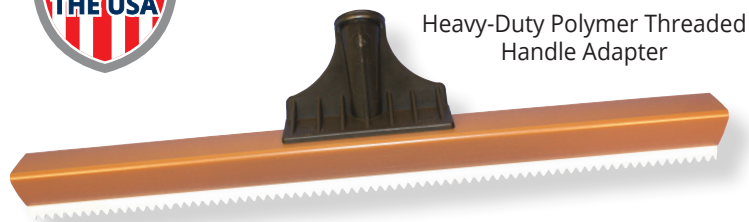

Topping and Underlayment "Super Squeegee"

A 24" low-angle / clamp style aluminum frame with a durable aluminum gusset bracing system is combined with a rounded edge, 3" exposed neoprene rubber blade. The result is a tool that effectively eliminates the need for troweling. A true spreading and smoothing squeegee allowing the contractor opportunity to save time and money when working with "toppings," underlayments and "high-mil" self-leveling materials. The contractor-friendly head to handle to surface angle has made this a very effective and popular tool. Easy change blade is clamped into the aluminum frame, not bolted through, making it easy to replace.



3" Neoprene Rubber Blade

Description	Blade Size 24 in.	Blade Size 36 in.
Squeegee with Threaded Handle Adapter	78601	78603
Squeegee with 66" Powder-Coated Aluminum Handle	78602	78604
Replacement Blade	SP50071	SP50072

Foam Squeegees



Side view of double-folded foam

Double edge foam squeegee with tapered handle adapter. Galvanized steel frame with reinforced handle socket.

Item No.	Description
47220	Squeegee - Foam Blade, 18" - NEW
47222	Squeegee - Foam Blade, 22" - NEW
47224	Squeegee - Foam Blade, 30" - NEW

Window Squeegees

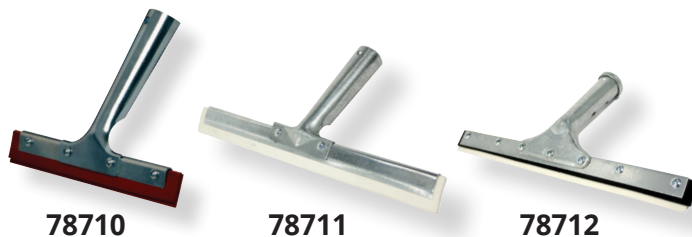

Our window squeegees offer high quality construction for professional use. They contain a flat non-marking Nitrile blade, superior & less expensive than red rubber. Any of our window squeegees can be used as a hand-tool or with a tapered wood handle.

Item No.	Description
78710	10" Window Squeegee
78711	12" White Window Squeegee - NEW
78712	12" White Heavy-Duty Window Squeegee - NEW
SP50130	Replacement Blade for 78710

CAM® Gauge Rakes



U.S. Patent 5,606,763

A patented "goof-proof" tool which applies materials at a precise, uniform depth. Apply decorative concrete "toppings," self leveling / high performance floor coating materials, and underlayments. CAM® depth settings range from 1/32" to 1-1/2". Includes an aluminum frame with either a threaded handle adapter or a powder-coated aluminum handle. Choose your frame size and handle option and then choose your CAM® set. Frames and sets are sold separately.

When one contact point wears down, you simply loosen the wing nut and rotate the CAM® to a fresh contact point. We use a "radial" edge design which maintains uniform coating thickness, even at varying handle angles and lengths.

CAM® GAUGE RAKE FRAMES AND CAM® SETS ARE SOLD SEPARATELY

- Head widths from 10" (hand-held) to 48". CAM® sets in depth settings from 1/32" to 1-1/2".
- The CAM® Gauge Rake is available with a milled threaded handle adapter or a 66" powder-coated aluminum handle. The 10" CAM® Rake is used for small areas and counter tops and has its own fixed handle with grip.

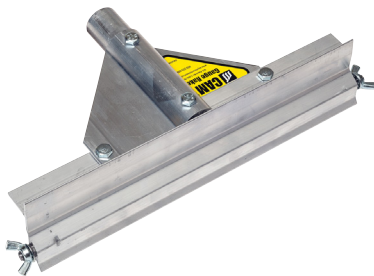

Midwest Rake® CAM® Gauge Rake

- Threaded Handle Adapter (Frame Only)
- CAM®s Sold Separately - See p. 11

12"	24"	36"	48"
57030	57000	57010	57020



Midwest Rake® CAM® Gauge Rake

- 66" Powder-Coated Aluminum Handle (Frame Only)
- CAM®s Sold Separately - See p. 11

12"	24"	36"	48"
57031	57001	57011	57021



Midwest Rake® CAM® Gauge Rake

- 82" Powder-Coated Aluminum Handle (Frame Only)
- CAM®s Sold Separately - See p. 11

12"	24"	36"	48"
57032	57002	57012	57022

57044 Midwest Rake® CAM® Gauge Rake Frame

- 10" Hand-Held Handle w/Grip
- CAM®s Sold Separately - See p. 11



Helpful Hint...

In many applications, gauge rakes can do the work in half the time it takes to use a squeegee... and with greater precision.

CAM® Gauge Rake CAM® Sets

(Two CAM®s Per Set)



1/32" 57078 Size A	1/24" 57079 Size B	1/16" 57081 Size 1	1/8" 57082 Size 2	3/16" 57083 Size 3	1/4" 57084 Size 4	5/16" 57085 Size 5	3/8" 57086 Size 6	1/2" 57088 Size 8
--------------------------	--------------------------	--------------------------	-------------------------	--------------------------	-------------------------	--------------------------	-------------------------	-------------------------

Not sure what depth you are going to need on your project? Use the Combo CAM® set.

This CAM® set has 5 separate size settings; 1 each of 1/16", 1/8", 3/16", 1/4" and 5/16". Sold separately from frame.

Larger CAM® Sets

Item No.	Description
57090	5/8" CAM® Set (2 Each), 3 Settings, Size 10
57096	1" CAM® Set (2 Each), 3 Settings, Size 16
57104	1-1/2" CAM® Set (2 Each), 2 Settings, Size 24



57080

CAM® Sets Are Also Available in 3-Packs

Item No.	Description
57180	CAM® 3-Pack – 1 Set (2 Each), Size 1 (57081), Size 2 (57082) and Size 4 (57084)
57181	CAM® 3-Pack – 1 Set (2 Each), Size 2 (57082), Size 4 (57084) and Size 6 (57086)

Small CAM® Sets (Two CAM®s Per Set)

Looking to apply coatings and slurries at greater than 30 mils? Our smaller CAM® Sets are ideal for Wet Film Thickness from 30 mils to 125 mils.

Customize Your Own CAM® Gauge Rake

or choose from a frame & blade combo (you supply the handle)

Now you can order the exact tool you use most. Supplied with a 24" wide frame and 1 CAM® set. Four different sizes of CAM® sets are available. Simply attach a handle and you have a complete tool. Replacement CAM® sets are available.

CAM® Size	Description
Size A	1/32" = Approx 30 mils
Size B	1/24" = Approx 42 mils
Size 1	1/16" = Approx 62 mils
Size 2	1/8" = Approx 125 mils



Item No.	Description
57201	24" CAM® Gauge Rake with Size 1 (1/16") CAM® Set (2 Each), THA*
57202	24" CAM® Gauge Rake with Size 2 (1/8") CAM® Set (2 Each), THA*
57203	24" CAM® Gauge Rake with Size 3 (3/16") CAM® Set (2 Each), THA*
57204	24" CAM® Gauge Rake with Size 4 (1/4") CAM® Set (2 Each), THA*
57206	24" CAM® Gauge Rake with Size 6 (3/8") CAM® Set (2 Each), THA*

*Threaded Handle Adapter

Key Product Feature

We use a "radial" edge CAM® design which maintains uniform coating thickness, even at varying handle angles and lengths.



Wire Gauge Rakes



58624



Radial contact points for a smoother push / pull action



58609

Applies self-leveling floor coatings and lower viscosity materials. Far superior to pin-type gauge rakes on the market. The strong spring-steel wires are formed in a “radial” or loop fashion, eliminating chatter and vibration common with pin-type gauge rakes. Radial contact points will maintain even at varying handle angles and lengths. The adjustable aluminum gate or bar can be set to any desired thickness from 0” to 5/8”. Replacement wires are available.

Description	Frame Width		
	Item No. 14"	Item No. 24"	Item No. 36"
Wire Gauge Rake with Threaded Handle Adapter	58714	58609	58734
Wire Gauge Rake with 66" Powder-Coated Aluminum Handle	-	58624	58736
Wire Gauge Rake with 82" Powder-Coated Aluminum Handle	-	58824	58738

Description	Item No.		
Replacement Wire Set (Set of 3 Wires)	68611	68611	-
Replacement Wire Set (Set of 4 Wires for 36" Width)	68616	-	68616

Sled-Style Gauge Rakes

These self-adjusting gauge rakes have been used by contractors for many years. Although not as precise as our other gauge rakes, they are value priced and will allow you to achieve a reasonably level depth when installing cementitious materials. They also allow you to easily move over rough surfaces. Styles and colors may vary, but the “sled-style” self-adjusting feature of this gauge rake will be a standard characteristic in this category. Our handle adapter is threaded to provide a secure connection.

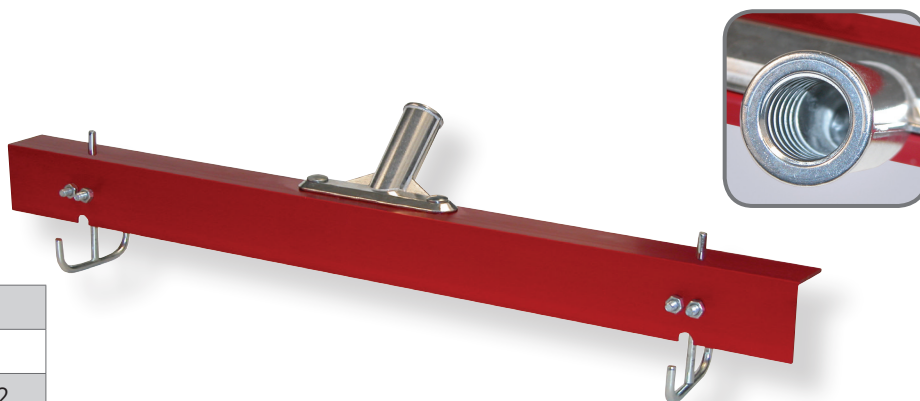

Item No.	Description
58420	24" Sled-Style Gauge Rake
58425	36" Sled-Style Gauge Rake
SA30034	Replacement Sleds - Set of 2
SP20020	Threaded Handle Adapter Kit

Heavy-Duty Cove Trowels

6" and 8" Wall Height Regulation Compliant

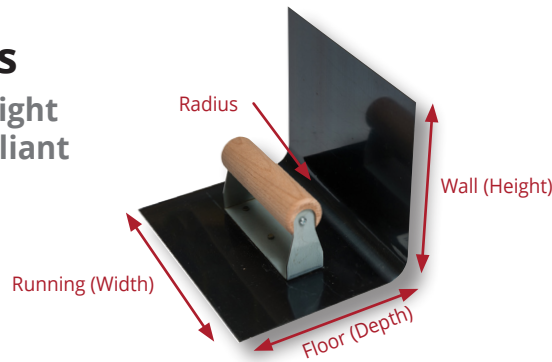

Item No.	Description
47481	3/4" Radius, 6" Wall (H) x 5-3/4" Floor (D) x 7-1/2" Running (W)
47482	3/4" Radius, 8" Wall (H) x 5-3/4" Floor (D) x 7-1/2" Running (W)
47485	1" Radius, 6" Wall (H) x 5-3/4" Floor (D) x 7-1/2" Running (W)
47486	1" Radius, 8" Wall (H) x 5-3/4" Floor (D) x 7-1/2" Running (W)

Standard Cove Trowels

High Carbon Blue Steel

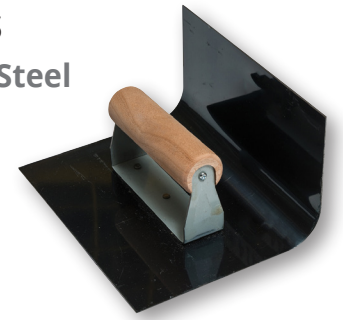

Item No.	Description
47414	Heavy-Duty 1" Radius, 3.5" H x 5-3/4" D x 7-1/2" W
47409	Heavy-Duty 3/4" Radius, 3.5" H x 5-3/4" D x 7-1/2" W
47411	Economy Regular 1" Radius, 3" H x 4" D x 6" W
47412	Economy Regular 1" Radius, 3" H x 6" D x 6" W

Tempered, ground and polished high-carbon spring steel trowels. Blades are fastened with hardened steel ground rivets. Wooden handles for better gripping power. Selected by manufacturers' "technical specialists" for decorative concrete and floor coating applications.

Rounded End Trowels



47465	4" x 16"
47466	4" x 18"
47475	3" x 12"
47477	3" x 16"

Notched Trowels

11" x 4-1/2" Overall

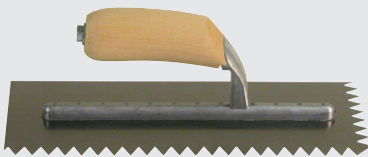

47406	3/16" V-Notch
47403	1/4" V-Notch
47402	1/2" V-Notch

"Spring Form" Trowels

Shorter Rib,
More Flexibility

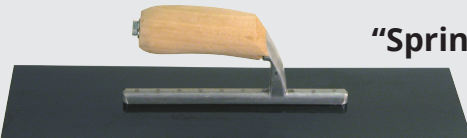

47470	Square Edge, 5" x 16"
47468	Rounded Edge, 5" x 16"

Epoxy Mortar Trowels



47460	3" x 12"
47461	3" x 16"

Finishing Trowels



47404	4" x 12"
47405	4" x 16"

Flexible Radius Trowel

This highly versatile, solvent-resistant rubber hand tool with flexible wings is ideal for the application of higher viscosity waterproofing, floor coating and sealing materials. Also effective along floor edges, for crack and patch filling on floors, and for the creation of a rounded radius along straight and radial edges when applying many different cementitious materials. Use with a threaded handle (see page 23).

The wing width is 6-1/2" and the length is 9-1/2". A 1-1/8" diameter tapered handle may be used with this tool (see page 23).



Item No.	Description
46010	Flexible Radius Trowel



SMOOTHERS & SPREADERS

Flexible Blade Smoother

This flexible 24" x 5" rounded corner steel blade is bent and angled to maximize blade contact with a range of surface coating materials. This smoothing tool can also serve as a spreading tool and even a surface preparation tool. It is most often used when troweling and / or smoothing overlay / underlay material (toppings) of a cementitious composition. The blade is contained in a durable aluminum frame with our superior aluminum gusset bracing system. This tool is available with a threaded handle adapter or with a 66" powder-coated aluminum handle.

Rounded Corner

Item No.	Description	Blade Size
78906	With Threaded Handle Adapter	24"
78907	With 66" Powder-Coated Aluminum Handle	24"
78926	With Threaded Handle Adapter	36"
78927	With 66" Powder-Coated Aluminum Handle	36"

Square Corner

Item No.	Description	Blade Size
78902	With Threaded Handle Adapter	24"
78903	With 66" Powder-Coated Aluminum Handle	24"

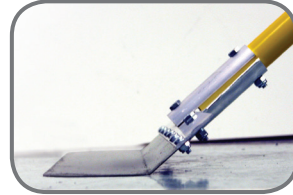

EXCLUSIVE



Spreaders / Smoother

These tools are lightweight, yet durable. They feature a 22" frame with a 23-1/2" x 2" heat-treated steel blade, and a reversible threaded handle adapter assembly allowing for use as a smoother or spreader.

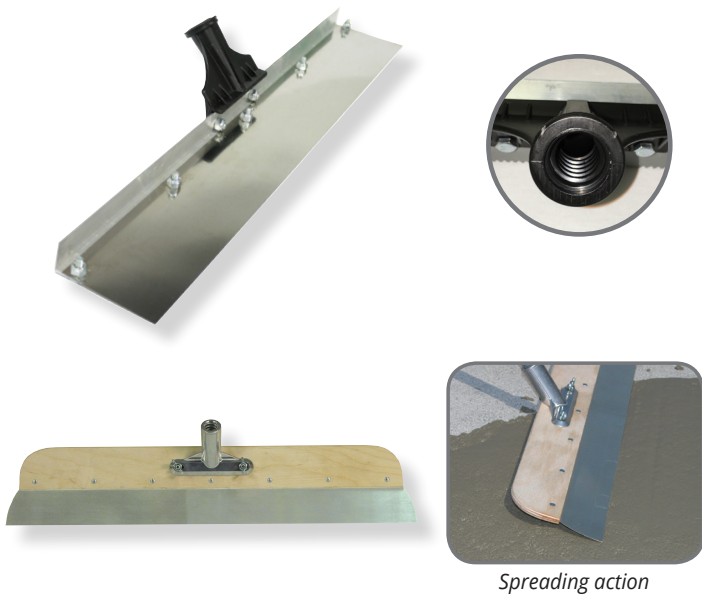

Item No.	Description
78932	22" Steel Spreader / Smoother, THA* - NEW
78930	Wood / Steel Smoother, Fan-Shaped Blade, THA*

*Threaded Handle Adapter

The Original Magic Trowel®

The Magic Trowel® is used to smooth the surface of applied cementitious overlays, particularly overlays of a more fluid consistency. A very effective finishing tool capable of creating a flawless surface.

Available in 12", 18", 22", 24" and 26" widths



47417

Comes with a threaded handle adapter

Item No.	Description
47415	12" Magic Trowel® with THA*
47416	18" Magic Trowel® with THA*
47417	22" Magic Trowel® with THA*
47418	24" Magic Trowel® with THA*
47419	26" Magic Trowel® with THA*

*Threaded Handle Adapter

NEW



MIDWEST RAKE®

ASSURANCE™
 GUARANTEED QUALITY AND CONSISTENCY

GUARANTEED QUALITY & CONSISTENCY FOR THE EPOXY FLOORING CONTRACTOR

Assurance™ covers are designed to meet the needs of flooring contractors. They are extremely shed-resistant and provide a consistent quality you can depend on.



KEY FEATURES OF WOVEN:

- Premium quality high density fabric
- Solvent resistant phenolic core
- Designed for use with epoxies and urethanes of all types

KEY FEATURES OF LOOPED:

- Ideal for applying cement urethanes
- Often used with aggregated coatings
- Great for spreading and back-rolling



Item No. Description

48202	9" Assurance™ Woven Shed-Resistant Roller Cover - 1/4" Nap
48203	9" Assurance™ Woven Shed-Resistant Roller Cover - 3/8" Nap
48204	9" Assurance™ Woven Shed-Resistant Roller Cover - 1/2" Nap
48208	18" Assurance™ Woven Shed-Resistant Roller Cover - 1/4" Nap
48209	18" Assurance™ Woven Shed Resistant Roller Cover - 3/8" Nap
48210	18" Assurance™ Woven Shed Resistant Roller Cover - 1/2" Nap
48015	9" Assurance™ Looped Polymer Roller Cover
48018	18" Assurance™ Looped Polymer Roller Cover

All 18" covers fit 1/4" axles and come with 1/4" (white) end caps. All 24" & 36" covers fit 3/8" axles and come with black 3/8" end caps.

Extra-Long Pro-Grade Roller Covers

Complete large flooring projects faster! See for yourself why a simple change to a 24" roller from the traditional 18" roller used in flooring can save significant time and labor. These roller covers are available in a shed-resistant woven fabric in widths of 24" and 36", with various nap lengths.

Description	Roller Width	Nap Length 3/8"	Nap Length 1/2"
Pro-Grade Woven Shed-Resistant Roller Cover	24"	48040	48042
Pro-Grade Woven Shed-Resistant Roller Cover	36"	48050	48052



Specialty Roller Covers

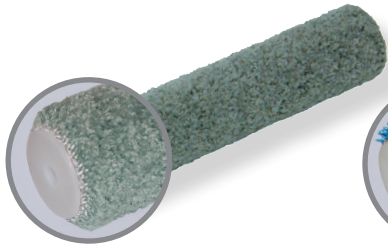

These Grey Carpet Nap Roller Covers are for the application of adhesives and coatings.

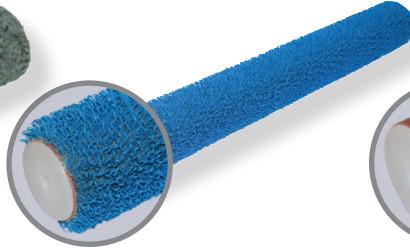

These Looped Polymer Roller Covers are most often used to "back-roll" applied coatings.

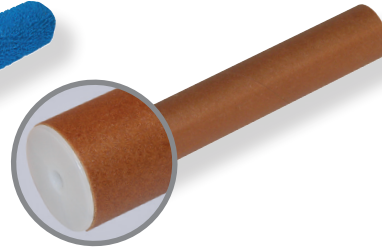

Our Phenolic Roller Covers are solvent-resistant and are used for the spreading and leveling of applied epoxies and mastics, anti-slip floor coverings and heavier coatings.

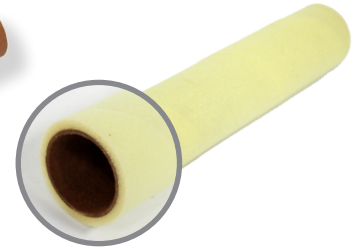

Pro Tiz Roller Covers are 3/16" high capacity, lint-free foam ideal for counter tops and have a phenolic core.

Item No. 9" No End Caps	Item No. 18" with 1/4" End Caps	Description
48015	48018	Looped Polymer Roller Cover
48025	48019	Phenolic Roller Cover
48014	48017	Grey Carpet Nap Roller Cover
48416	-	9" Pro Tiz Roller Cover - 3/16" Foam



Wooster® Roller Covers Not all fibers are created equal. With roller covers, like any textile item, the quality level of the chosen fiber ends up dictating the richness of the fabric being produced. Wooster® works closely with their fabric suppliers to choose and then modify fibers to ensure that they hold and release coatings better than competitive covers.

*See page 20 for more info on the Seymour Midwest® & Wooster® relationship.



Item No.	Description
48414	9" Microplush™ Roller Cover - 5/16" Nap



Item No.	Description
48429	9" Candy Stripe® Roller Cover - 1/4" Nap



Item No.	Description
48419	9" Mohair Blend™ Roller Cover - 1/4" Nap
48420	18" Mohair Blend™ Roller Cover - 1/4" Nap, with 1/4" End Caps



Item No.	Description
48430	9" Epoxy Glide™ Roller Cover - 1/4" Nap
48431	18" Epoxy Glide™ Roller Cover - 1/4" Nap, with 1/4" End Caps



Item No.	Description
48432	9" Pro/Doo-Z® FTP™ - 3/16" Nap
48433	18" Pro/Doo-Z® FTP™ - 3/16" Nap with 1/4" End Caps
48434	9" Pro/Doo-Z® FTP™ - 3/8" Nap
48435	18" Pro/Doo-Z® FTP™ - 3/8" Nap with 1/4" End Caps



Item No.	Description
48421	9" Pro/Doo-Z® Roller Cover - 3/16" Nap
48422	18" Pro/Doo-Z® Roller Cover - 3/16" Nap with 1/4" End Caps
48423	9" Pro/Doo-Z® Roller Cover - 3/8" Nap
48424	18" Pro/Doo-Z® Roller Cover - 3/8" Nap with 1/4" End Caps
48426	9" Pro/Doo-Z® Roller Cover - 1/2" Nap
48428	18" Pro/Doo-Z® Roller Cover - 1/2" Nap with 1/4" End Caps

ROLLER COVERS, ROLLERS, & BRUSHES



Item No.	Description
48441	9" Painters Solution™ Roller Cover - 3/16" Nap
48443	9" Painters Solution™ Roller Cover - 3/8" Nap
48444	9" Painters Solution™ Roller Cover - 1/2" Nap
48446	9" Painters Solution™ Roller Cover - 3/4" Nap
48447	18" Painters Solution™ Roller Cover - 3/16" Nap, with 1/4" End Caps
48449	18" Painters Solution™ Roller Cover - 3/8" Nap, with 1/4" End Caps
48450	18" Painters Solution™ Roller Cover - 1/2" Nap, with 1/4" End Caps
48451	18" Painters Solution™ Roller Cover - 3/4" Nap, with 1/4" End Caps



Item No.	Description
48485	9" American Contractor™ Knit Cover - 3/8" Nap
48486	9" American Contractor™ Knit Cover - 1/2" Nap
48487	9" American Contractor™ Knit Cover - 3/4" Nap
48488	9" American Contractor™ Knit Cover - 1-1/4" Nap
48481	18" American Contractor™ Knit Cover - 3/8" Nap, with 1/4" End Caps
48482	18" American Contractor™ Knit Cover - 1/2" Nap, with 1/4" End Caps
48483	18" American Contractor™ Knit Cover - 3/4" Nap, with 1/4" End Caps
48484	18" American Contractor™ Knit Cover - 1-1/4" Nap, with 1/4" End Caps

Mini Rollers and Frames



Item No.	Description
48409	4-1/2" Jumbo-Koter® Microplush Roller Cover - 5/16" Nap, 2-pk
48411	Jumbo-Koter® Mini Frame
48413	6-1/2" Jumbo-Koter® Microplush Roller Cover - 5/16" Nap, 2-pk
48415	6-1/2" Jumbo-Koter® Pro Foam™ Roller Cover - 2-pk
48470	6-1/2" Acme™ Mini Roller Rod Frame
48471	6-1/2" Acme™ Perlon Knit Covers, 3/8" Nap, 10-pk
48472	6-1/2" Acme™ Shed Resistant Covers - 3/8" Nap, 10-pk
48480	6-1/2" Mini-Koter™ Shed Resistant Covers - 3/8" Nap, 2-pk



Item No.	Description
48470	6-1/2" Acme™ Mini Roller Rod Frame
48471	6-1/2" Acme™ Perlon Knit Covers, 3/8" Nap, 10-pk
48472	6-1/2" Acme™ Shed Resistant Covers - 3/8" Nap, 10-pk
48475	4" Super/Fab® Knit 3/4"

Chip Brushes

Chip brushes are ideal for flooring and protective and marine contractors who require a disposable and inexpensive brush to trim in around corners and edges.

Item No.	Description
48131	2" White Bristle Chip Brush
48132	2-1/2" White Bristle Chip Brush
48133	3" White Bristle Chip Brush
48134	4" White Bristle Chip Brush
48142	2-1/2" White Bristle Double Thick Chip Brush
48143	3" White Bristle Double Thick Chip Brush
48144	4" White Bristle Double Thick Chip Brush
48459	1" Solvent-Proof Chip Brush
48460	1-1/2" Solvent-Proof Chip Brush
48461	2" Solvent-Proof Chip Brush
48462	2-1/2" Solvent-Proof Chip Brush
48463	3" Solvent-Proof Chip Brush
48464	4" Solvent-Proof Chip Brush



Roller Gauge End Caps

The thick film roller gauge works for urethane cement, cement overlays, epoxies, antiskids, and vapor barriers. Spread, gauge, and back roll; snaps on ends of roller in seconds; precise gauging, no guessing, no waste.

Item No.	Description
48182	Roller Gauge End Caps, Low Mil 6-pk, Yellow, Approx 4 mils
48183	Roller Gauge End Caps, Med Mil 6-pk, Red, Approx 12 mils
48184	Roller Gauge End Caps, High Mil 6-pk, Blue, Approx 22 mils
48185	Roller Gauge End Caps, Thick Film 6-pk, Gray, 1/2" Depth - NEW
48186	Roller Gauge End Caps, Thick Film 6-pk, Gray, 1/4" Depth - NEW

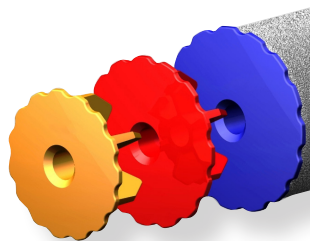

End Caps



Item No.	Description
SA30005	1/4" End Caps (Set of 2)
SA30042	1/4" End Caps (Box of 24)
SA30045	3/8" End Caps (Set of 2)
SA30048	3/8" End Caps (Bag of 24)

Roller Frames

The **48400** has a quick release spring that prevents roller slippage, smooth bearings for reliable applications, a polypropylene grip and a threaded handle adapter. It is one of the best universal roller frames on the market. The **48403** is a traditional "paint roller" style frame and the handle contains a threaded handle adapter. The **48410** adjusts to hold all roller covers from 9" to 18" wide. It has a rigid and durable steel frame with a threaded handle adapter, yet weighs less than one pound. The **48418** is a lightweight, yet the durable polypropylene 18" non-adjustable frame can accommodate any of the 18" roller covers we offer. This frame offers a threaded handle adapter and the fiber-glass-reinforced nylon legs are replaceable.

Item No.	Description
48400	9" Wooster® Sherlock® Frame
48403	9" Wooster® Magikage® Ninety Frame
48405	9" Wooster® Acme™ Cage Frame
48410	Wooster® Sherlock Wide Boy™ 18" Frame
48418	Wooster® Big Ben® 18" Frame
SA30006	Replacement Nylon Legs for 48418 - Set of 2

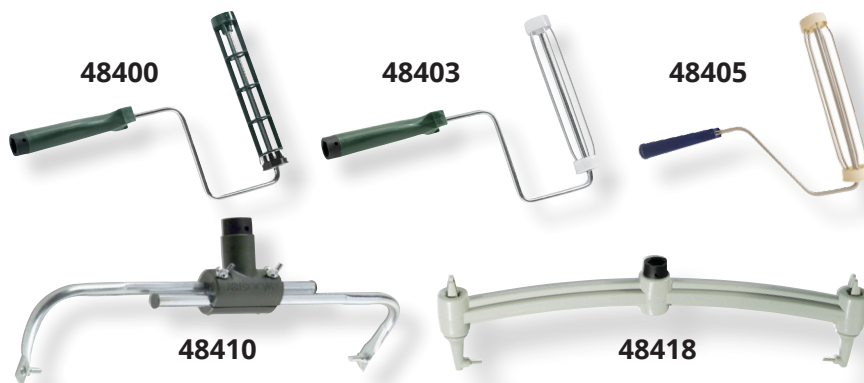

Complete large flooring projects faster! See for yourself why a simple change to a 24" roller from the traditional 18" roller used in flooring can save significant time and labor.

Heavy-Duty Fixed Width Aluminum Frames **EXCLUSIVE**

These are the most durable frames on the market. They are available in widths of 9", 18", 24" and 36" and can be used with any of our roller covers. Our own design, it is the same frame used with our spiked and aluminum rollers. The frames can be ordered with either a threaded handle adapter or with a fixed handle assembly. These heavy-duty solid aluminum frames are solvent-resistant and can be easily cleaned after each use. Special 3/8" post hole end caps are available for use with these exclusive frames when using 9" - 36" roller covers. These polypropylene end caps are used to adapt the frames to any 1-1/2" roller. They are sold in quantities of 1 pair or a bag of 24 (see top of page).



Ask about custom sizes up to 60" in width.

For Handle Options See Page 23

Description	Frame Width				
	Item No. 9"	Item No. 18"	Item No. 24"	Item No. 36"	Item No. 48"
Heavy-Duty Aluminum Frame with Threaded Handle Adapter	60108	60110	60113	60115	60117
Heavy-Duty Aluminum Frame with 66" Powder-Coated Aluminum Handle	60109	60112	60114	60116	60118

“Metal-Tined” Spiked Roller Covers

A more dense steel tine configuration, modeled after the traditional “porcupine” roller. These rollers have a phenolic core. The 18” cover comes with 1/4” holed end caps. Metal-tined spiked rollers work remarkably well with cementitious and Gypsum based overlays to promote self-leveling and reduce out-gassing.

Description	Item No. 9” No End Caps	Item No. 18” with End Caps
1/2” Metal-Tined Spiked Roller Cover	48090	48091
1-1/4” Metal-Tined Spiked Roller Cover	48093	48094

For frame options see page 18

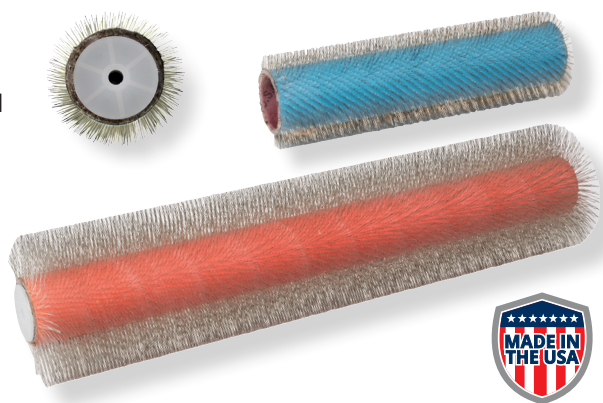

Polyethylene Spiked Rollers

We are one of the very few manufacturers in the world to offer rigid solvent-resistant and aluminum cored polypropylene spiked rollers for the floor coating industry. Our Spiked Rollers are constructed by stacking solvent-resistant, interlocking rings of spikes around an aluminum core.

These spiked rollers are vital in ensuring proper floor coating material adhesion. They are designed to be used on freshly applied floor coatings for the purpose of releasing trapped gas as well as to assist in the leveling process of several varieties of floor coatings. These rollers are easy to clean, allowing for repeated use. The applicator should also wear spiked shoes while using a spiked roller (see pages 4 - 5).

We manufacture our spikes and end caps out of solvent-resistant High-Density (HD) and Ultra-High Molecular Weight (UHMW) Polyethylene, respectively, for easier cleanup and extended wear. Spikes are available in 7/16”, 9/16” and 13/16” lengths. These rollers also come in 36” and 48” widths which are preferred by some applicators when very large, flat areas need to be treated quickly. We also have 1-1/2” and 3” widths on special frames for very tight areas. Each of our 18” or wider rollers come with a heavy-duty aluminum frame, high-grade stainless steel axles, our superior gusset bracing and a maximum strength threaded handle adapter. Our 9” rollers come with either a special radial frame or a heavy-duty aluminum frame, both with a threaded handle adapter. The 1-1/2” and 3” rollers come on special handled frames. (Standard “paint-roller” frames do not work with our 9” spiked rollers).

Replacement rollers for all widths and spike lengths are available below. Replacement frame assemblies are located on page 18.



9/16” Super Sharp (44 Spikes)

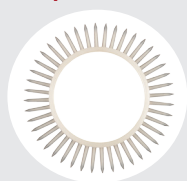

Head Width	Radial Roller Frame	Threaded Handle Adapter	66” Handle	Replacement Roller
9”	59458	59459	59559	SA10062
18”	-	59468	59568	SA10063
24”	-	59474	59574	SA10064
36”	-	59486	59586	SA10065
48”	-	59498	59598	SA10066

Item No.	Description
59001	1-1/2” with 7/16” Spikes
59003	3” with 7/16” Spikes
59403	3” with 9/16” Spikes
59103	3” with 13/16” Spikes

7/16” Super Sharp (33 Spikes)

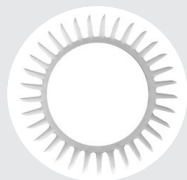

Head Width	Radial Roller Frame	Threaded Handle Adapter	66” Handle	Replacement Roller
9”	59009	59209	59509	SA10043
18”	-	59218	59518	SA10023
24”	-	59224	59524	SA10025
36”	-	59236	59536	SA10026
48”	-	59248	59548	SA10027

Helpful Hint...

Many factors can contribute to the creation of trapped gas bubbles in freshly applied protective coatings, particularly on floors. Our 7/16” and 13/16” Super Sharp Spiked Rollers are effectively used on most floor coatings and your choice between the two depends on the mil thickness specifications of the material being applied.

Where a great abundance of bubbles are anticipated or seen, our 9/16” Super Sharp Spiked Rollers are ideal because of the greater number of spikes per square inch of roller surface.

Most often, either the 7/16” or the 13/16” Super Sharp Spiked Rollers are adequate to get the job done.

13/16” Super Sharp (33 Spikes)

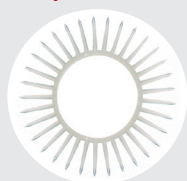

Head Width	Radial Roller Frame	Threaded Handle Adapter	66” Handle	Replacement Roller
9”	59109	59309	59609	SA10044
18”	-	59318	59618	SA10029
24”	-	59324	59624	SA10030
36”	-	59336	59636	SA10031
48”	-	59348	59648	SA10032

Blunt Spiked & Stub Rollers

We make a number of specialty tools featuring these hybrid spikes. Unlike our sharp-tipped spiked rollers, used to remove trapped bubbles from freshly applied floor coatings, these roller covers are actually used as application tools. They are often used to force and compress aggregate materials into a variety of overlayments, or create a special surface finish. We can custom make a variety of tools using the “blunt” and “stub” spikes. Because of the hollow aluminum core, these rollers can be weighted.



59774

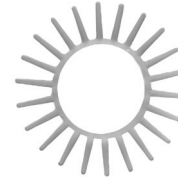

Blunt Spikes
13/16" spikes
(22 spikes per ring)

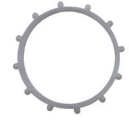

Stubs
1/8" stubs
(12 stubs per ring)

Roller Width

Description	Item No. 9"	Item No. 18"	Item No. 24"	Item No. 36"	Item No. 48"
Blunt Spiked Roller on Radial Roller Frame	59108	-	-	-	-
Blunt Spiked Roller on Heavy-Duty Aluminum Frame with THA*	59709	59718	59724	59736	59748
Blunt Spiked Roller on Heavy-Duty Aluminum Frame with 66" PCAH**	59809	59818	59824	59836	59848
Replacement Blunt Spiked Roller	-	SA10014	SA10015	SA10016	SA10017
Stub Roller on Radial Roller Frame	59758	-	-	-	-
Stub Roller on Heavy-Duty Aluminum Frame with THA*	59759	59768	59774	-	-
Replacement Stub Roller	SA10072	SA10073	SA10074	-	-

*THA=Threaded Handle Adapter **Powder-Coated Aluminum Handle



MIDWEST RAKE®

Looking for a traditional painting tool such as a brush, roller, frame or specialty tool that you don't see in our catalog? We now can give you access to thousands of **Wooster®** items as part of our expanded relationship.

- Single source all of your coatings tools, supplies and applicators
- New customized joint merchandising solutions and point of sale material available
- Customized programs tailored to meet your needs
- Local sales support

Ribbed Rollers

Ribbed rollers are used to evenly distribute resin and other bonding materials when installing fiberglass and other high performance fabric and mesh laminate reinforcement systems. The use of these rollers enhances the fiberglass / fabric saturation and containment, while removing air bubbles and pockets. These rollers are useful in the installation of tank linings, concrete secondary containment systems and concrete mortar laminate reinforcement flooring applications. Aluminum rollers are the industry standard. All styles have fins designed with just enough angle to increase strength without sacrificing air relief. These rollers are designed to reduce sheared fiber by insuring a radius is machined on each fin. Resin can be burned off with a torch.

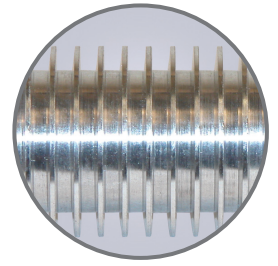

Replaceable Sleeve Ribbed Rollers

These aluminum rollers fit directly on standard paint roller frames. They have a 2" diameter with a 1-1/2" diameter center to slip over paint roller frames just like a paint roller cover. The rollers are made from strong 6063 aluminum and are machined to exacting standards of the 2" aluminum rollers shown below. They are sold as complete tools, with replacement sleeves available.

Item No.	Description
48334	4" Aluminum Ribbed Roller, 2" Diameter, Paint Frame - Complete Tool
48337	7" Aluminum Ribbed Roller, 2" Diameter, Paint Frame - Complete Tool
48339	9" Aluminum Ribbed Roller, 2" Diameter, Paint Frame - Complete Tool
48304	4" x 2" Aluminum Ribbed Roller Replacement Sleeve, 1-1/2" Inside Diameter
48307	7" x 2" Aluminum Ribbed Roller Replacement Sleeve, 1-1/2" Inside Diameter
48309	9" x 2" Aluminum Ribbed Roller Replacement Sleeve, 1-1/2" Inside Diameter
48318	18" x 2" Aluminum Ribbed Roller Sleeve, 1-1/2" Inside Diameter
48124	4" Heavy-Duty Roller Frame with Threaded Handle Adapter
48127	7" Heavy-Duty Roller Frame with Threaded Handle Adapter
48129	9" Heavy-Duty Roller Frame with Threaded Handle Adapter

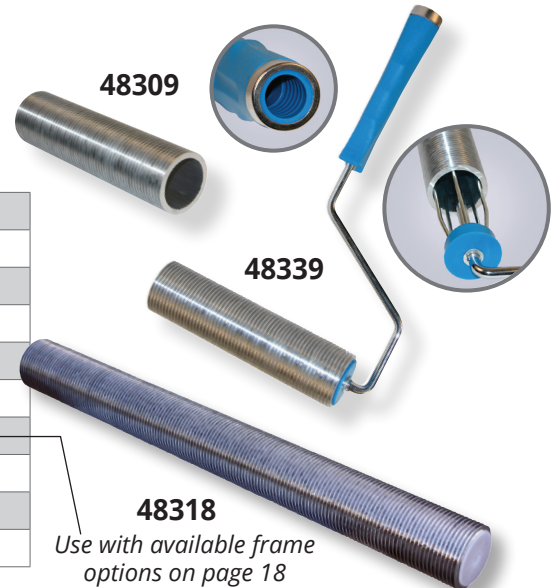

Ribbed Rollers with Wooden Handles

These aluminum rollers have a traditional deep fin, straight groove design. Machined radius fin corners reduce glass fiber shearing. They have reduced clearance for less resin contamination. These rollers come on strong galvanized steel frames with undersized handle bore for a tight fit and long life. The wood handles are steel ferruled and accept standard threaded extension handles (see page 23).

Item No.	Description
48313	3" Aluminum Ribbed Roller, 1" Diameter, Wood Handle - Complete Tool
48316	6" Aluminum Ribbed Roller, 1" Diameter, Wood Handle - Complete Tool
48326	6" Aluminum Ribbed Roller, 2" Diameter, Wood Handle - Complete Tool
48329	9" Aluminum Ribbed Roller, 2" Diameter, Wood Handle - Complete Tool

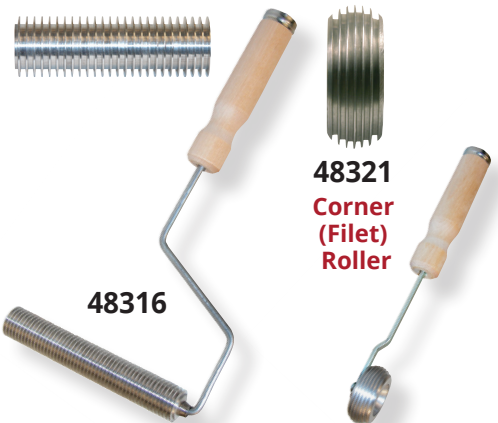

Specialty Ribbed Rollers

These specialty rollers are designed for concave surfaces and filets where flat rollers are not effective. All of these rollers come with strong steel frames and ferrule reinforced wood handles with handle adapters that accept standard extension handles (see page 23 for handles). All of these rollers are machined with the deepest fins possible for efficient air relief and excellent lay up properties.

Item No.	Description
48321	3/4" Aluminum Corner (Filet) Ribbed Roller, 2-1/2" Diameter - Complete Tool
48323	3" Aluminum (Barrel) Radius Ribbed Roller, 2" Diameter - Complete Tool
48310	3" Aluminum Inverted Radius Ribbed Roller, 1" Diameter - Complete Tool

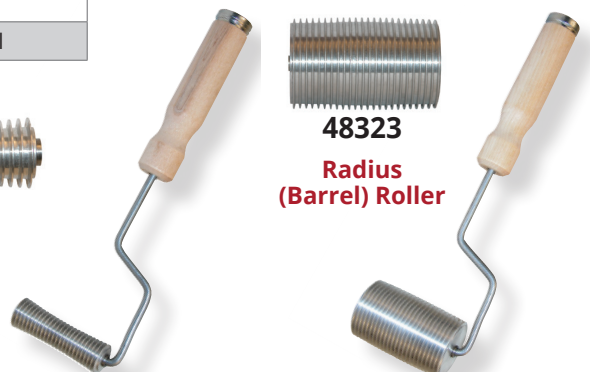

Fiberglass Scissors

These 10" knife-edge fiberglass scissors are very rigid and American Made. The knife edge design insures clean, crisp shearing action for all fiberglass materials. The increased blade angle of 45° over the 15° angle of standard scissors reduces effort and leaves a cleaner, more even cut.



48300



BROOMS, BRUSHES, & SCRAPERS

Wire Stripping Brush This brush has a curved, sander-style handle that comfortably fits the palm and allows the user to press down more firmly when scrubbing. The staggered tufts, instead of rows, provide better coverage and eliminate rake marks.

Item No.	Description
48037	Midwest Rake® Wire Stripping Brush, 6-3/4" x 2-1/4" Block Trim, 1-1/8" - 88 Tufts

Duo Broom Best for the removal of "fine" materials because of its combination of strong 3" polypropylene bristles with an added layer of outside bristles. Features our super-strong, unique and durable overlapping gusset bracing system.

Item No.	Description
82104	Structron® 24" Duo Broom, 60" Ergonomic Yellow Powder-Coated Aluminum Handle
82106	Structron® 36" Duo Broom, 60" Ergonomic Yellow Powder-Coated Aluminum Handle

Street / Landscape Broom Stiff, 5" orange poly-corn bristles and comes with our super-strong, unique and durable overlapping gusset bracing system.

Item No.	Description
82118	Structron® 18" Street / Landscape Broom, 60" Ergonomic Yellow Powder-Coated Aluminum Handle

General Purpose Broom Features our super-strong, unique and durable overlapping gusset bracing system.

Item No.	Description
82124	Structron® 24" General Purpose Broom, 60" Ergonomic Yellow Powder-Coated Aluminum Handle
82136	Structron® 36" General Purpose Broom, 60" Ergonomic Yellow Powder-Coated Aluminum Handle

Epoxy / Thick Fluid Coating Brush 13" hand-held brush has 3-1/2" Tampico bristles that are strong and chemical resistant.

Item No.	Description
48035	Epoxy / Thick Fluid Coating Brush, Block Size 6" x 1-3/4"

Protective Coating Brush Polypropylene bristles plus a squeegee blade make this an ideal protective coating application tool.

Item No.	Description
82900	18" Coating Brush with Squeegee, 60" x 15/16" Metal Threaded Tip Wood Handle
47240	18" Protective Coating Brush with Squeegee Blade (Head Only)

Scrapers

The 16 gauge stainless steel blade, available in widths of 8", 12" and 16", is attached to our super-strong, unique and durable overlapping gusset bracing system along with a 66" powder-coated aluminum handle. This is one of the most powerful scrapers on the market. The blade can be sharpened for project needs.

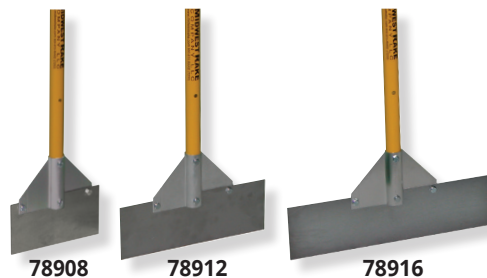

Description	Blade Width		
	Item No. 8"	Item No. 12"	Item No. 16"
Stainless Steel Scraper	78908	78912	78916
Replacement Blade	SP50027	SP50028	SP50029

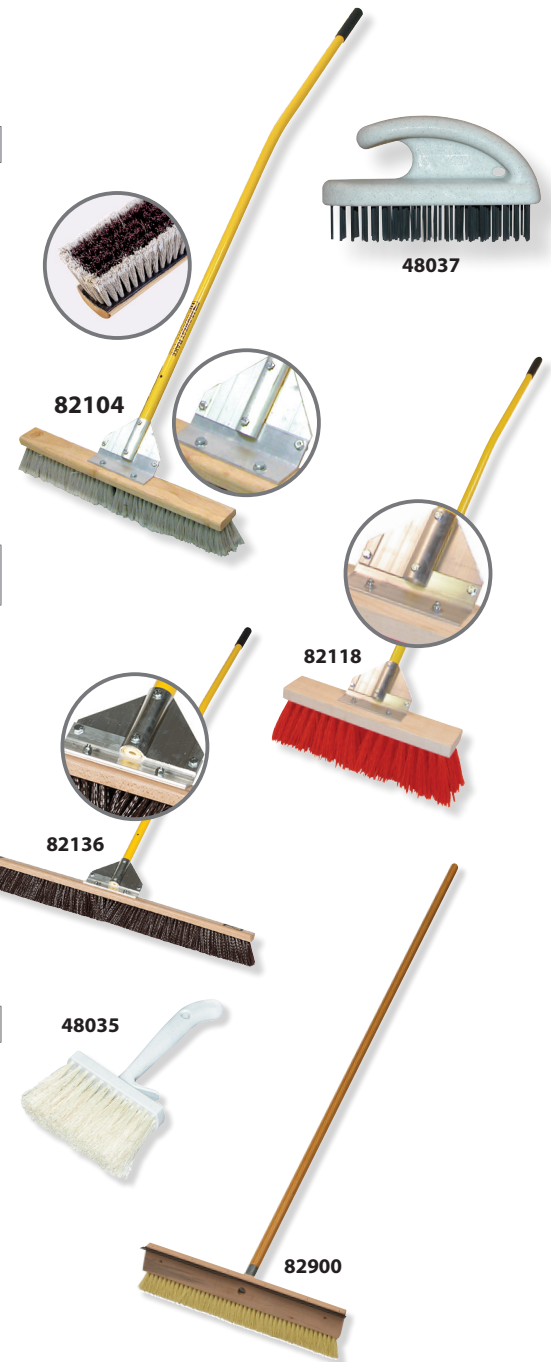

Extension Handle Options

Powder-coated aluminum handles with milled aluminum threaded tips - for use with threaded handle adapters. We designed this milled threaded tip handle to provide the "tightest" fit with our tools that are available with our exclusive threaded handle adapter. These handles have a durable, milled threaded aluminum tip for added strength - no more broken tips - and come in 60", 66", and 82" lengths. We also have a 60" extension handle available to use with these handles which has a threaded milled aluminum tip on one end and a threaded milled aluminum receptacle on the other end.



I.

Hardwood Handles - We offer a variety of high quality hardwood handles, with either a tapered tip or a metal threaded tip.

Item No.	Description
A. SA20173	60" PCAH* Handle with Aluminum Threaded Tip
B. SA20174	66" PCAH* Handle with Aluminum Threaded Tip
C. SA20175	82" PCAH* Handle with Aluminum Threaded Tip
D. SA20228	60" Yellow Extension Aluminum Handle, Threaded Tip and Socket
E. SP20220	1-1/8" x 60" Hardwood Handle, Tapered Tip
F. SP20221	1-1/8" x 72" Hardwood Handle, Tapered Tip
G. SP20215	15/16" x 60" Hardwood Handle, Metal Threaded Tip
H. SP20216	15/16" x 72" Hardwood Handle, Metal Threaded Tip
I. SA20221	3'-6' Fiberglass Telescopic Extension Handle, Milled Aluminum Threaded Tip

*Powder-Coated Aluminum Handle

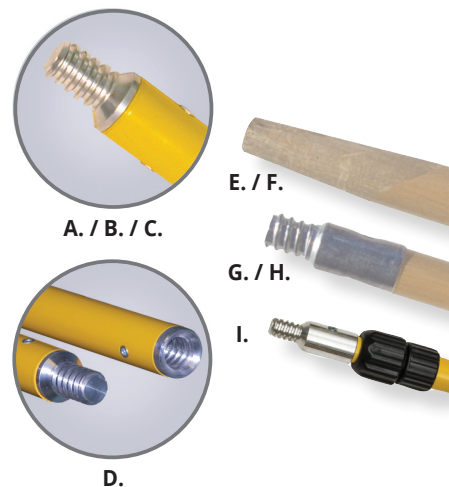

A. / B. / C.

E. / F.

G. / H.

I.

D.

Fiberglass Extension Handles - Prized by painting contractors, cleaning professionals and other users who look for extended reach with maximum adjustability, our extension handles have been top-sellers for decades. Our patented STĀ-LOCK mechanism is the most convenient and reliable to use. Just twist to lock in any position.



Structron® Superhandle® II Ultra Extension Handle with Milled Aluminum Tip

- Milled aluminum tip
- Fiberglass telescoping handle with cushion grip
- Ultra threaded tip replacement Kit (60279)

Item No.	Description
60270	1' - 2' Handle with STĀ-LOK & End Cap
60271	2' - 4' Handle with Dual Lock
60276	3' - 6' Handle with Dual Lock
60272	4' - 8' Handle with Dual Lock
60273	6' - 12' Handle with Dual Lock
60274	8' - 16' Handle with Dual Lock
60275	8' - 24' Handle with Dual Lock



Structron® Superhandle® II extension handle

- Threaded #5 Acme aluminum tip
- Fiberglass telescoping handle with cushion grip
- Threaded tip replacement kit (60259)

Item No.	Description
60250	1' - 2' Handle with STĀ-LOK & End Cap
60251	2' - 4' Handle with Dual Lock
60256	3' - 6' Handle with Dual Lock
60252	4' - 8' Handle with Dual Lock
60253	6' - 12' Handle with Dual Lock
60254	8' - 16' Handle with Dual Lock
60255	8' - 24' Handle with Dual Lock



Structron® Superhandle® Extension Handle

- Threaded #5 Acme aluminum tip
- Fiberglass telescoping handle with collar lock, cushion grip
- Threaded tip replacement kit (60259)

Item No.	Description
60245	2' - 4' Handle
60244	3' - 6' Handle
60246	4' - 8' Handle
60247	6' - 12' Handle
60248	8' - 16' Handle



Structron® Straight Extension Handle

- Threaded #5 Acme aluminum tip
- Fiberglass handle with vinyl end cap
- Threaded tip replacement kit (60259)

Item No.	Description
60240	1" x 48" Handle
60241	1" x 60" Handle
60242	1" x 72" Handle

MISCELLANEOUS TOOLS

Solvent-Resistant Gloves

These nitrile, flock-lined, form fitting gloves are resistant to solvents used regularly within the coating industry. They are available in three sizes.



Description	Size 9 - L	Size 10 - XL	Size 11 - XXL
Solvent-Resistant Gloves (Pair)	46209	46210	46211

Disposable Nitrile Gloves

Powder free disposable nitrile gloves come 100 per box. Available in 2 sizes.



Description	Size L	Size XL
Disposable Nitrile Gloves	46214	46215

Recycled White Cotton Knitcloth

Item No.	Description
46217	4 LB #5 Block Recycled White Cotton Knitcloth



Non-Skid Shoe Covers

Item No.	Description
46219	Blue Non-Skid Shoe Covers - 10 Pair Per Pack



Containers for Mixing

Item No.	Description
46221	1 Quart Multi-Mix Container
46223	2-1/2 Quart Multi-Mix Container
46225	5 Quart Multi-Mix Container
46228	5 Gallon Project Bucket - White
46229	5 Gallon Natural Multi-Mix Bucket
46230	10 Quart Multi-Mix Container



Stick-Ems™ Level Pegs

Stick-Ems™ Level Pegs are used to achieve a level surface. Use them with your leveling unit. Cut to height and stick this flexible, self-adhesive rubber / vinyl peg right to the substrate. Pour leveling product right over the top. The peg will not float to the surface and becomes part of the cement matrix. Gauged in millimeters up to 65 mm (2-1/2").



Small (65mm) Pack of 100	Description
46280	Stick-Ems™ Level Pegs

Mixing Barrels

Mixing barrels can be hard to come by, reconditioned or new. The 15 gallon mixing barrel (European style) with fixed side handles and sealing lid is the standard. Used to mix more cementitious materials prior to application.

- HD polyethylene
- Belted lids
- Web or pegged handles

Item No.	Description
46240	15 Gallon Mixing Barrel
46250	15 Gallon Mixing Barrel - Reconditioned*

*Subject to availability



Plastic Paint Trays

Item No.	Description
48465	Deep Well Plastic Tray - 2 Quart
48466	Big Ben® Tray - 1 Gallon Capacity



Wideboy™ Bucket & Liners

This bucket has a five gallon working capacity to save refill time. Designed for large jobs and the professional in mind featuring a unique paint bucket and tray all in one. Resists solvents and paint buildup.

- 14" x 24" x 10"
- Built-in 19" wide roll-off area
- No tip design & heavy-duty 5/16" galvanized bail
- Comfort grip for moving when filled
- Durable, seamless, green polypropylene



Item No.	Description
48467	Sherlock® Wideboy™ Bucket with Handle - 5 Gallon
48468	Quick N Clean™ Wideboy™ Liner - 5-pk

MIXERS & MEASURING WHEELS

Low Viscosity Mixers

The Pro-Grade mixers are the choice of many contractors. These mixers have low shear for minimal air entrapment while mixing. The Pro-Grade mixers are constructed of quality powder-coated steel and are available in 2 sizes; a 1-2 gallon paddle with a 3-1/2" turbine style head on a 19-3/4" x 5/16" diameter hex shaft or a 2-5 gallon paddle with a 4-3/4" turbine style head on a 23-1/2" x 3/8" diameter hex shaft.

Jiffy Mixers are also available in two sizes; a 1-2 gallon and a 2-5 gallon. They are made of 304 stainless steel and fit all 1/4" - 3/4" chucked power tools. The blade actions are characterized by a smooth, thorough, non-air sucking and non-splashing action.

Our Helix mixers are made from polypropylene and specially designed to reach the bottom edges of the paint can for a thorough mix. It mounts to your hex-chuck power drill for impressive speed.

Item No.	Description
47442	1-2 Gallon Small Pro-Grade Mixing Paddle
47444	2-5 Gallon Large Pro-Grade Mixing Paddle
47432	1-2 Gallon Small Jiffy Mixer
47434	2-5 Gallon Large Jiffy Mixer
47431	1 Gallon Helix Mixer
47433	5 Gallon Helix Mixer
47436	2-3/8" X 17" Paint Mixer
47438	4" x 23-1/2" Paint Mixer



Pro-Grade



High Viscosity Mixing Paddles

These mixers are used by those in the decorative concrete, and stamping markets. The "football" shaped cage configurations are ideal for mixing more viscous "topping" and cementitious materials. The larger 10" x 6" head is designed for barrel mixing. The smaller 6" x 4" head is ideal for 5 gallon quantities. Both mixers effectively remove air without splash-out. Both have an overall length of 26" with a hex shaft.

Item No.	Description
47422	Small 5 Gallon Mixer
47425	Large Mixer
47429	Box Mixer, 5" Diameter, 7/16" x 23" Hex Shaft

Measuring Wheels

A fast, practical way to measure distance, indoors or outdoors, on any surface.

Item No.	Description
85701	Kenyon® Small Telescoping 1' Measuring Wheel
85703	Kenyon® GroundScaper 3' Measuring Wheel
85704	Kenyon® GroundScaper 4' Measuring Wheel
85712	Kenyon® Wide-Trak 2' Measuring Wheel
85713	Kenyon® Pro-Grade 3' Measuring Wheel
85714	Kenyon® Pro-Grade 4' Measuring Wheel



MERCHANDISING

CUSTOM PLANOGRAMS: We custom design planograms to maximize customer appeal and sell-through. A well done planogram can communicate that you are a destination source for coatings tools and supplies to your customers. Careful planning can ensure that premium wall space yields a maximum return on your inventory investment.

12' PREMIUM GRIDWALL MERCHANDISER

This merchandiser is for any reseller who wants to position themselves as a destination source for coatings tools and supplies. Its size and customizable aspect make it the first choice for those who are serious about growing their business. Several signage options are available; ask for details.



PHOTO COURTESY OF BARNSCO DECORATIVE CONCRETE SUPPLY
LOCATED IN FARMERS BRANCH, TX

8' PLANOGRAM

An 8' planogram provides the right combination of flexibility and size for an extended assortment of tools and supplies.

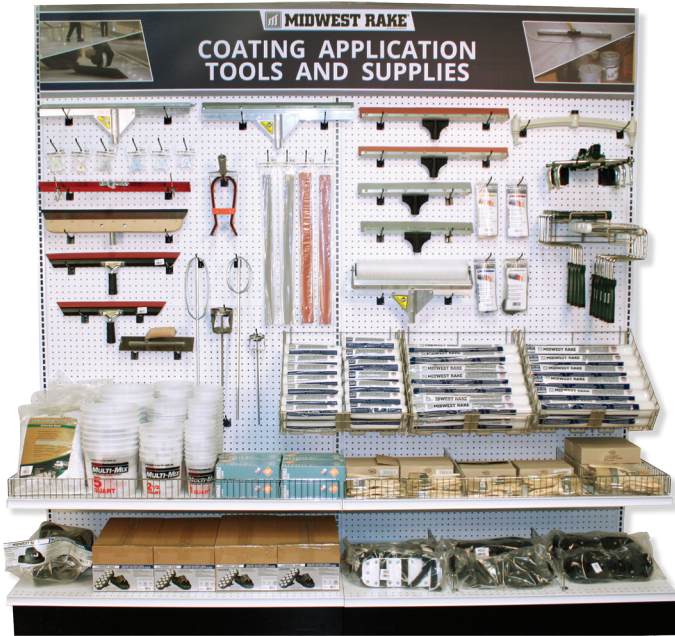

4' PLANOGRAM

The 4' planogram can be customized to include a targeted assortment of traditional applicators and supplies and is often used in conjunction with a 360 degree tower merchandiser to display the coatings application tools.

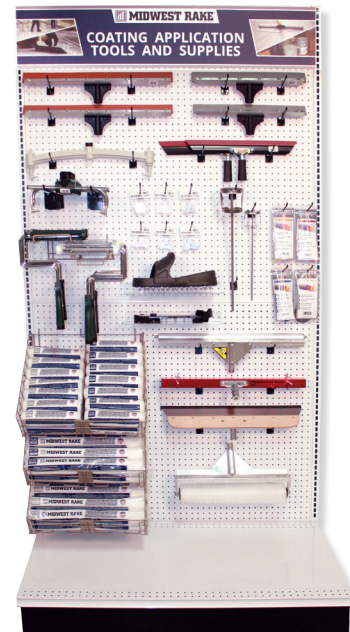

FLOOR MERCHANDISERS: Floor merchandisers can double or triple your inventory turns by attracting customer attention and maximizing space efficiently. We have several options available and can customize a display to fit your needs.



360 DEGREE TOWER MERCHANDISER

The 360 degree tower merchandiser only takes up 3 square feet of floor space and provides complete display of tools from three sides. Options are available which allow for all types of hooks and baskets to be utilized. Comes complete with gridwall, hooks, and full color signage.

SKU - 58015
NO TOOLS INCLUDED

MINI 2' MERCHANDISER

This small free standing display rack will allow you to display core tools while maximizing space. Comes complete with gridwall, legs, hooks, and full color signage

SKU - 58013
NO TOOLS INCLUDED



EXTENSION HANDLE RACK



SKU - YDIS104
NO TOOLS INCLUDED

BROOM DISPLAY RACK



SKU - 82999
NO TOOLS INCLUDED



MINI 2' FOOTWEAR MERCHANDISER

Set yourself apart by displaying various types of footwear with this 2' free standing display rack. Comes complete with gridwall, legs, hooks, and full color signage

SKU - 58014
FOOTWEAR NOT INCLUDED

Item No. Description

58013	Mini 2' Standard Display Rack - No Tools Included
58014	Mini 2' Footwear Display Rack - Footwear Not Included
58015	Merchandiser Display - Grids & Signs, Catalogs, Hooks - No Tools Included
58016	Merchandiser Display - Slatgrids & Signs, Catalogs, Hooks - No Tools Included
82999	Broom Merchandiser Rack
YDIS001	Seymour Midwest Merchandising Steel Gridwall Section, 2' x 8', General Tool Wall Display
YDIS003	4" Black Steel Gridwall Hook
YDIS004	9" Black Steel Magazine Holder for Gridwall
YDIS008	8" Black Steel Gridwall Hook
YDIS104	20" x 20" Steel Rack for Fiberglass Extension Handles
YDIS107	10" Black Steel Pegboard Hook
YDIS181	10" x 36" Midwest Rake® Sign
YDIS185	12" x 24" Coating Application Sign

Item No. Description

YDIS191	T-Shaped Legs for Gridwall
YDIS209	Shoe-In® Promo Packet
YDIS214	36" x 36", Broom Display Rack
YDIS222	12" x 6" Acrylic Gridwall Shelf
YDIS224	22" x 7" Sign Holder for Gridwall
YDIS243	144" x 15" Three-Part Coatings Sign
YDIS244	48" x 15" Midwest Rake® Sign
YDIS274	10" x 48" Midwest Rake® Sign
YDIS275	15" x 96" Midwest Rake® Sign
YDIS290	4" Black Steel Pegboard Hook
YDIS291	18" Black Adjustable Roller Cover Basket for Pegboard
YDIS292	Double Sided Roller Hanger for Pegboard
YDIS293	2' x 6' Black Steel Slatgrid
YDIS294	2' x 8' Black Steel Slatgrid
YDIS295	7" x 22" PVC, Double Sided, Footwear Sign

INDEX

46001	7	46219	24	47167	8	47466	13
46002	7	46221	24	47174	8	47468	13
46005	7	46223	24	47175	8	47470	13
46010	13	46225	24	47176	8	47475	13
46102	5	46228	24	47177	8	47477	13
46103	5	46229	24	47184	8	47481	13
46104	5	46230	24	47185	8	47482	13
46106	5	46240	24	47186	8	48014	16
46107	5	46250	24	47187	8	48015	15,16
46108	5	46280	24	47220	9	48017	16
46110	5	47120	8	47222	9	48018	15,16
46112	5	47121	8	47224	9	48019	16
46120	5	47122	8	47240	22	48025	16
46121	5	47123	8	47402	13	48035	22
46122	5	47136	8	47403	13	48037	22
46125	5	47137	8	47404	13	48040	15
46126	5	47138	8	47405	13	48042	15
46127	5	47139	8	47406	13	48050	15
46128	5	47140	8	47409	13	48052	15
46129	5	47141	8	47411	13	48090	19
46130	5	47142	8	47412	13	48091	19
46131	4	47143	8	47414	13	48093	19
46132	4	47146	8	47415	14	48094	19
46141	5	47147	8	47416	14	48124	21
46142	5	47148	8	47417	14	48127	21
46143	5	47149	8	47418	14	48129	21
46151	5	47150	8	47419	14	48131	17
46152	5	47151	8	47422	25	48132	17
46153	5	47152	8	47425	25	48133	17
46161	4	47153	8	47429	25	48134	17
46162	4	47156	8	47431	25	48142	17
46163	4	47157	8	47432	25	48143	17
46171	4	47158	8	47433	25	48144	17
46172	4	47159	8	47434	25	48182	18
46173	4	47160	8	47436	25	48183	18
46209	24	47161	8	47438	25	48184	18
46210	24	47162	8	47442	25	48185	18
46211	24	47163	8	47444	25	48186	18
46214	24	47164	8	47460	13	48202	15
46215	24	47165	8	47461	13	48203	15
46217	24	47166	8	47465	13	48204	15

48208	15	48432	16	57011	10	58824	12
48209	15	48433	16	57012	10	59001	19
48210	15	48434	16	57020	10	59003	19
48300	21	48435	16	57021	10	59009	19
48304	21	48441	17	57022	10	59103	19
48307	21	48443	17	57030	10	59108	20
48309	21	48444	17	57031	10	59109	19
48310	21	48446	17	57032	10	59209	19
48313	21	48447	17	57044	10	59218	19
48316	21	48449	17	57078	11	59224	19
48318	21	48450	17	57079	11	59236	19
48321	21	48451	17	57080	11	59248	19
48323	21	48459	17	57081	11	59309	19
48326	21	48460	17	57082	11	59318	19
48329	21	48461	17	57083	11	59324	19
48334	21	48462	17	57084	11	59336	19
48337	21	48463	17	57085	11	59348	19
48339	21	48464	17	57086	11	59403	19
48400	18	48465	24	57088	11	59458	19
48403	18	48466	24	57090	11	59459	19
48404	17	48467	24	57096	11	59468	19
48405	18	48468	24	57104	11	59474	19
48409	17	48470	17	57180	11	59486	19
48410	18	48471	17	57181	11	59498	19
48411	17	48472	17	57201	11	59509	19
48413	17	48475	17	57202	11	59518	19
48414	16	48480	17	57203	11	59524	19
48415	17	48481	17	57204	11	59536	19
48416	16	48482	17	57206	11	59548	19
48418	18	48483	17	58013	27	59559	19
48419	16	48484	17	58014	27	59568	19
48420	16	48485	13,17	58015	27	59574	19
48421	16	48486	13,17	58016	27	59586	19
48422	16	48487	17	58420	12	59598	19
48423	16	48488	17	58425	12	59609	19
48424	16	48490	17	58609	12	59618	19
48426	16	48491	17	58624	12	59624	19
48428	16	57000	10	58714	12	59636	19
48429	16	57001	10	58734	12	59648	19
48430	16	57002	10	58736	12	59709	20
48431	16	57010	10	58738	12	59718	20

INDEX

59724	20	60274	23	78710	9	79075	6
59736	20	60275	23	78711	9	79080	6
59748	20	60276	23	78712	9	79085	6
59758	20	68611	12	78731	9	79090	6
59759	20	68616	12	78750	9	79093	6
59768	20	78000	6	78751	9	79095	6
59774	20	78010	6	78752	9	79100	6
59809	20	78015	6	78753	9	79105	6
59818	20	78020	6	78760	9	79110	6
59824	20	78040	6	78761	9	79113	6
59836	20	78100	6	78762	9	79115	6
59848	20	78108	7	78763	9	79120	6
60108	18	78110	6	78902	14	79205	6
60109	18	78114	7	78903	14	79210	6
60110	18	78115	6	78906	14	79213	6
60112	18	78116	7	78907	14	79215	6
60113	18	78118	7	78908	22	79220	6
60114	18	78120	6	78912	22	79225	6
60115	18	78122	7	78916	22	79230	6
60116	18	78124	7	78926	14	79233	6
60117	18	78125	7	78927	14	79235	6
60118	18	78126	7	78930	14	79240	6
60240	23	78128	7	78932	14	79245	6
60241	23	78129	7	79005	6	79250	6
60242	23	78140	6	79010	6	79253	6
60244	23	78200	6	79013	6	79255	6
60245	23	78210	6	79015	6	79260	6
60246	23	78215	6	79020	6	79265	6
60247	23	78220	6	79025	6	79270	6
60248	23	78240	6	79030	6	79273	6
60250	23	78323	7	79033	6	79275	6
60251	23	78546	7	79035	6	79280	6
60252	23	78548	7	79040	6	79285	6
60253	23	78554	7	79045	6	79290	6
60254	23	78556	7	79050	6	79293	6
60255	23	78601	9	79053	6	79295	6
60256	23	78602	9	79055	6	79300	6
60270	23	78603	9	79060	6	79305	6
60271	23	78604	9	79065	6	79310	6
60272	23	78708	7	79070	6	79313	6
60273	23	78709	7	79073	6	79315	6

79320	6	79793	6	SA10072	20	YDIS224	27
79405	6	79795	6	SA10073	20	YDIS243	27
79410	6	79800	6	SA10074	20	YDIS244	27
79415	6	79805	6	SA20173	23	YDIS274	27
79420	6	79810	6	SA20174	23	YDIS275	27
79425	6	79813	6	SA20175	23	YDIS290	27
79430	6	79815	6	SA20221	23	YDIS291	27
79505	6	79820	6	SA20228	23	YDIS292	27
79510	6	82104	22	SA30005	18	YDIS293	27
79515	6	82106	22	SA30006	18	YDIS294	27
79520	6	82118	22	SA30034	12	YDIS295	27
79525	6	82124	22	SA30042	18		
79530	6	82136	22	SA30045	18		
79605	6	82900	22	SA30048	18		
79610	6	82999	27	SP20020	12		
79615	6	85701	25	SP20215	23		
79620	6	85703	25	SP20216	23		
79625	6	85704	25	SP20220	23		
79630	6	85712	25	SP20221	23		
79705	6	85713	25	SP50027	22		
79710	6	85714	25	SP50028	22		
79713	6			SP50029	22		
79715	6	S		SP50071	9		
79720	6	SA10014	20	SP50072	9		
79725	6	SA10015	20	SP50120	7		
79730	6	SA10016	20	SP50121	7		
79733	6	SA10017	20	SP50122	7		
79735	6	SA10023	19	SP50130	9		
79740	6	SA10025	19				
79745	6	SA10026	19	Y			
79750	6	SA10027	19	YDIS001	27		
79753	6	SA10029	19	YDIS003	27		
79755	6	SA10030	19	YDIS004	27		
79760	6	SA10031	19	YDIS008	27		
79765	6	SA10032	19	YDIS104	27		
79770	6	SA10043	19	YDIS107	27		
79773	6	SA10044	19	YDIS181	27		
79775	6	SA10062	19	YDIS185	27		
79780	6	SA10063	19	YDIS191	27		
79785	6	SA10064	19	YDIS209	27		
79790	6	SA10065	19	YDIS214	27		
		SA10066	19	YDIS222	27		



MIDWEST RAKE®

COATINGS APPLICATION
TOOLS & SUPPLIES



0 46385 09116 5

#YDIS297 © 2016 Seymour Midwest LLC